



Loudspeaker
System

XRT28
Owner's Manual

WARNING - TO REDUCE RISK OF FIRE OR ELECTRICAL SHOCK, DO NOT EXPOSE THIS EQUIPMENT TO RAIN OR MOISTURE.

NO USER-SERVICEABLE PARTS INSIDE. REFER SERVICING TO QUALIFIED PERSONNEL.

IMPORTANT SAFETY INSTRUCTIONS!

PLEASE READ THEM BEFORE OPERATING THIS EQUIPMENT.

1. Read these instructions.
2. Keep these instructions.
3. Heed all warnings.
4. Follow all instructions.
5. Do not use this apparatus near water.
6. Clean only with a dry cloth.
7. **Warning: To reduce risk of fire or electrical shock, do not expose this equipment to rain or moisture. This unit is capable of producing high sound pressure levels. Continued exposure to high sound pressure levels can cause permanent hearing impairment or loss. User caution is advised and ear protection is recommended when playing at high volumes.**
8. Do not install near any heat sources such as radiators, heat registers, stoves, or other apparatus (including amplifiers) that produce heat.
9. Protect the connection cables from being walked on or pinched particularly at the point where they exit from the apparatus.
10. Only use attachments/accessories specified by the manufacturer.
11. Use only with the cart, stand, tripod, bracket, or table specified by the manufacturer, or sold with the apparatus. When a cart is used, use caution when moving the cart/apparatus combination to avoid injury from tip-over.
12. Disconnect this apparatus during lightning storms or when unused for long periods of time.
13. Refer all servicing to qualified service personnel. Servicing is required when the apparatus has been damaged in any way, liquid has been spilled or objects have fallen onto the apparatus, the apparatus has been exposed to rain or moisture, does not operate normally, or has been dropped.
14. Do not expose this equipment to dripping or splashing and ensure that no objects filled with liquids, such as vases, are placed on the equipment.



Thank You

Your decision to own this McIntosh XRT28 Loudspeaker System ranks you at the very top among discriminating music listeners. You now have “The Best.” The McIntosh dedication to “Quality,” is assurance that you will receive many years of musical enjoyment from this unit.

Please take a short time to read the information in this manual. We want you to be as familiar as possible with all the features and functions of your new McIntosh.

Please Take A Moment

The serial number, purchase date and McIntosh Dealer name are important to you for possible insurance claim or future service. The spaces below have been provided for you to record that information:

Serial Number: _____

Purchase Date: _____

Dealer Name: _____

Technical Assistance

If at any time you have questions about your McIntosh product, contact your McIntosh Dealer who is familiar with your McIntosh equipment and any other brands that may be part of your system. If you or your Dealer wish additional help concerning a suspected problem, you can receive technical assistance for all McIntosh products at:

McIntosh Laboratory, Inc.
2 Chambers Street
Binghamton, New York 13903
Phone: 607-723-1545
Fax: 607-723-3636

Customer Service

If it is determined that your McIntosh product is in need of repair, you can return it to your Dealer. You can also return it to the McIntosh Laboratory Service Department. For assistance on factory repair return procedure, contact the McIntosh Service Department at:

McIntosh Laboratory, Inc.
2 Chambers Street
Binghamton, New York 13903
Phone: 607-723-3515
Fax: 607-723-1917

Table of Contents

Safety Instructions	2
Thank You and Please Take a Moment	3
Technical Assistance and Customer Service	3
Table of Contents and Important Information	3
Introduction	4
Performance Features	5
Dimensions	6
Installation using the Column Base	8
How to Connect using a single amplifier	10
How to Connect using two amplifiers	12
How to Connect using three amplifiers	14
Specifications	18
Packing Instruction	19

Important Information

Caution: The XRT28 Loudspeaker System weight is 139.5 pounds (63.4kg). It requires two or more persons to safely handle when moving.

- Loudspeaker Cables of adequate size are important to ensure that there will be no significant power loss or heating. Cable size is specified in Gauge numbers or AWG (American Wire Gauge). The smaller the Gauge number, the larger the wire size:
If the Loudspeaker Cables are 25 feet (7.62m) or less, use at least 18 Gauge (AWG) wire size or larger.
If the Loudspeaker Cables are 50 feet (38.1m) or less, use at least 14 Gauge (AWG) wire size or larger.
If the Loudspeaker Cables are 100 feet (76.2m) or less, use at least 12 Gauge (AWG) wire size or larger.
The Loudspeaker Connection Terminals can accept up to 12 Gauge (AWG) wire.*
- For additional connection information, refer to the owner's manual(s) for any component(s) connected to the XRT28 Loudspeaker.*
- The XRT28's built-in speaker protection incorporates five automatic resetting solid-state devices in the crossover network. One protects the tweeters, one for the midranges and three for the woofers. The protection allows a certain amount of overdrive but extended periods will trigger protection. If an obvious lack of high, mid or low frequencies is noticed, the Protection Device may have activated. These devices will automatically reset when the volume level is reduced significantly and kept low until the output of the affected Loudspeaker Element returns to normal.*
- When the XRT28 Loudspeaker System is driven by more than one amplifier, the output levels of the different amplifiers connected to the Loudspeaker System must be adjusted to achieve a proper balance between the low, midrange and high frequencies reproduced. This adjustment is best achieved through the use of audio test equipment operated by a qualified installer.*

Introduction

McIntosh Acoustic Engineers have refined the line source Column Loudspeaker System concept to provide superior sound reproduction in a full range system.

The Loudspeaker System utilizes a patented Column Design¹ with multiple four inch Midrange LD/HP² Magnetic Circuit Design Drivers and one inch soft dome Tweeters. Refer to figure 1. Since the audio power fed to a column is distributed among all the drivers, each driver does not have to work as hard, resulting in greater power handling capability and a dramatic reduction in distortion. The Sound Waves from the Column produce a Cylindrical Wave Front with a stable symmetrical horizontal sound dispersion to minimize undesirable floor and ceiling reflections that could detract from a stable sound image. In the illustration the Loudspeaker on the left side produces a Cy-



Figure 1

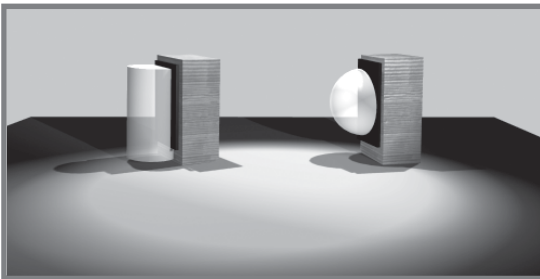

Figure 2



Figure 3

lindrical Wave Front and the Loudspeaker on the right side produces a conventional Spherical Wave Front. Refer to figure 2.

The Low Frequency Section of the System consists of two 10 inch Woofers. They have a large magnet assembly and long cone excursions with very low levels of harmonic distortion and frequency response down to 16Hz. Refer to figure 3. The Woofer also incorporates McIntosh's Patented LD/HP² Magnetic Circuit Design with shielding to greatly reduce any external magnetic field, that could distort the video image on a TV/ Monitor placed next to the XRT28 Loudspeaker. Extensive investigating and testing resulted in a new design concept which utilizes a pair of aluminum shorting sleeves in the magnetic circuit. Refer to figure 4. The sleeves virtually eliminate the negative influence of the fluctuating voice coil field on the permanent magnet field. This results in lower distortion due to more linear magnetic flux in the voice coil gap. Refer to figure 5. Additional benefits are less volume compression due to improved heat transfer through the sleeves and a cooler operating voice coil. Both measurements, as well as critical listening, reveal ten times less distortion than previous designs. A good example of this low distortion is incredible smoothness and clarity in the reproduction of the human voice.



Figure 4

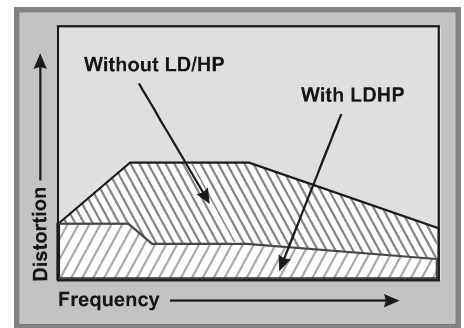

Figure 5

The Crossover Network used in the XRT28 Loudspeaker System is designed to ensure an even frequency

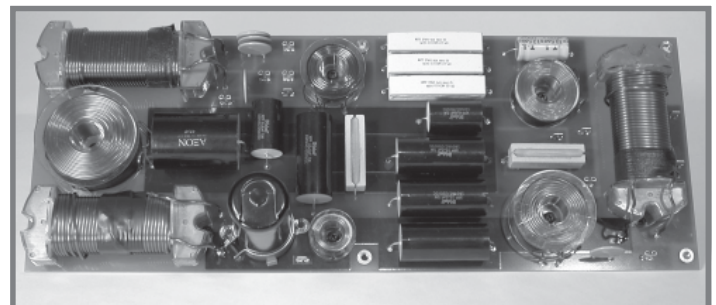

Figure 6

¹COLUMN Pat. No. 4,267,405

²LD/HP Pat. No. 5,151,943

response over the entire audible range. The Network utilizes both Second and Third Order design utilizing Capacitors and Inductors with high current capacity. Refer to figure 6. There are two different types of low loss (DCR) Inductors in the network, each one chosen not to exhibit any core saturation even at high power levels. This prevents the addition of distortion to the music at any frequency. The Capacitors used include low loss (ESR) Polypropylene and Mylar types. The Network also utilize self resetting high current Poly-Switches to provide an extra measure of protection.

The enclosures are an important part of the XRT28 Loudspeaker System. The Loudspeaker System utilizes a massive extruded

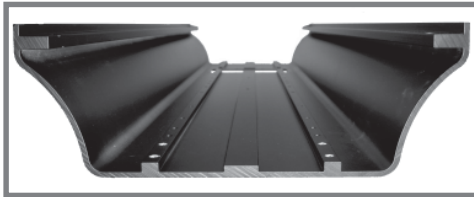

Figure 7

aluminum enclosure that houses the 20 four inch Midrange and 16 one inch Tweeter Drivers. Refer to figure 7. It also has multiple front to back internal braces to form a dampened rigid Column Structure. The Column's small footprint allows for a variety of different placements in a room.

Performance Features

● Patented LD/HP Technology

The McIntosh Low Frequency and Midrange Loudspeaker Elements feature the patented LD/HP Magnetic Circuit Design. This design, when compared to conventional Loudspeaker Elements, reduces distortion significantly. It also increases power handling and efficiency.

● Neodymium-Iron-Boron Alloy Magnets

The 20 four inch Midranges and 16 one inch Dome Tweeters all use this Alloy. The Neodymium-Iron-Boron Alloy has the highest flux density per unit of volume and helps to keep the Column weight to a minimum.

● Shielded Magnetic Field

The XRT28 may be used in Home Theater Installations near a television receiver or monitor without causing the television image to degrade. McIntosh has designed special shielding around the magnetic structure of the XRT28 Loudspeaker Elements to prevent interference.

● High Power Handling

The Loudspeaker Elements and Crossover Components of the XRT28 are all chosen for use with powerful amplifiers up to 1,200 watts.

● Superior Imaging

Locating the Column of Tweeters between the two Columns of Midranges helps to generate a symmetrical horizontal polar response for superior imaging.

● Versatile Operation and Placement

In addition to the regular connections, the XRT28 Loudspeaker System provides separate connections for Bi-Amplification and Tri-Amplification hookups.

● Gold Plated Input Connectors

The XRT28 input connectors are gold plated for superior corrosion resistance and high electrical conductivity.

XRT28 Dimensions

The following dimensions can assist in determining the best location for your XRT28 Loudspeaker System.

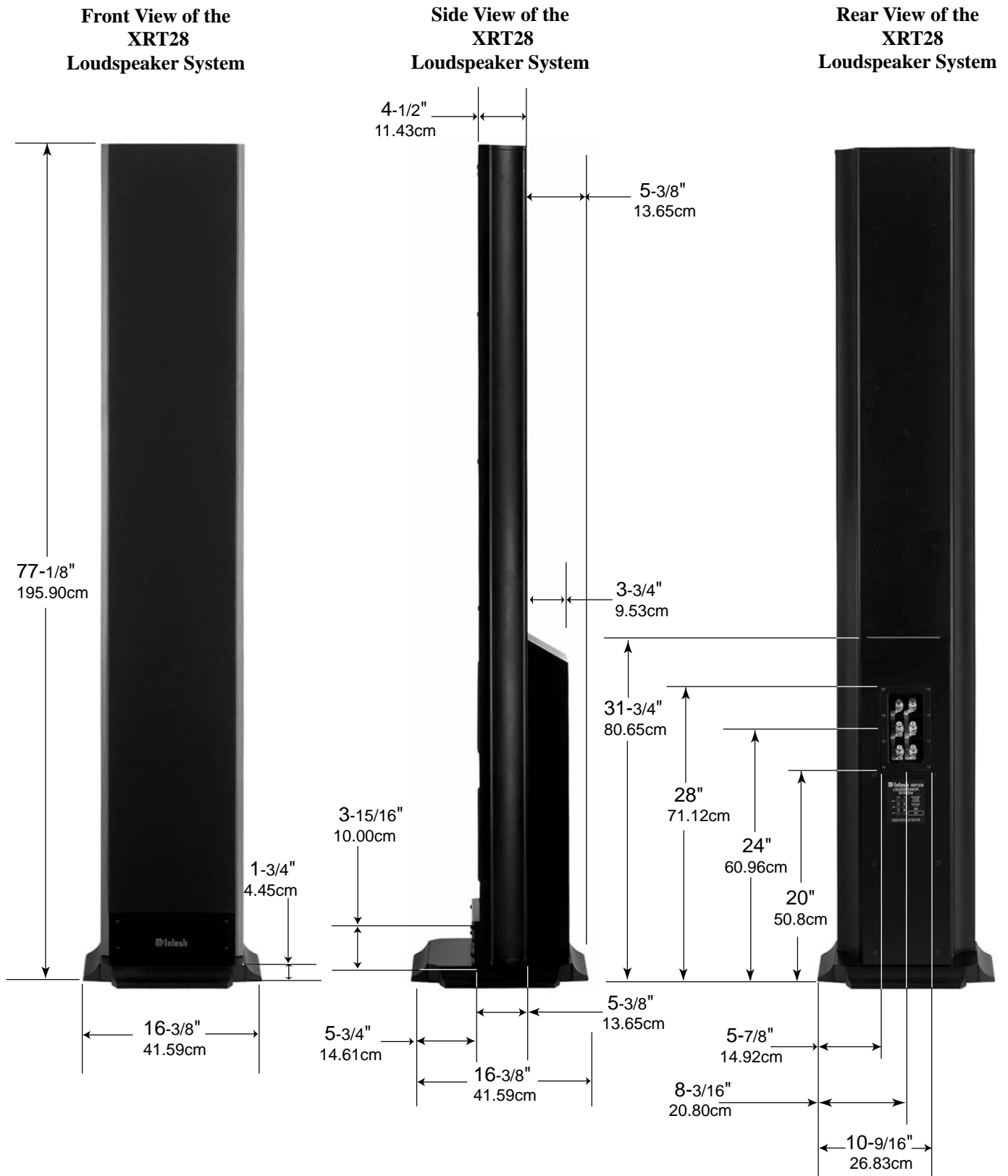

**Front View of the
XRT28
Loudspeaker System**

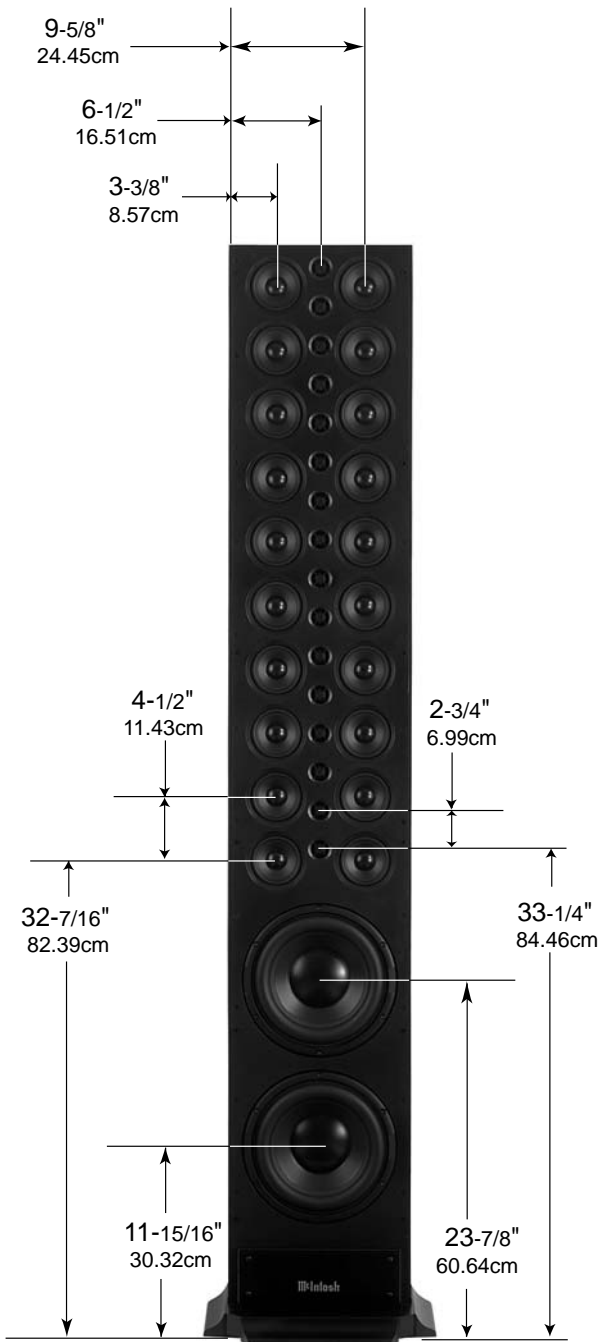

**End View and Base of the
XRT28
Loudspeaker System**

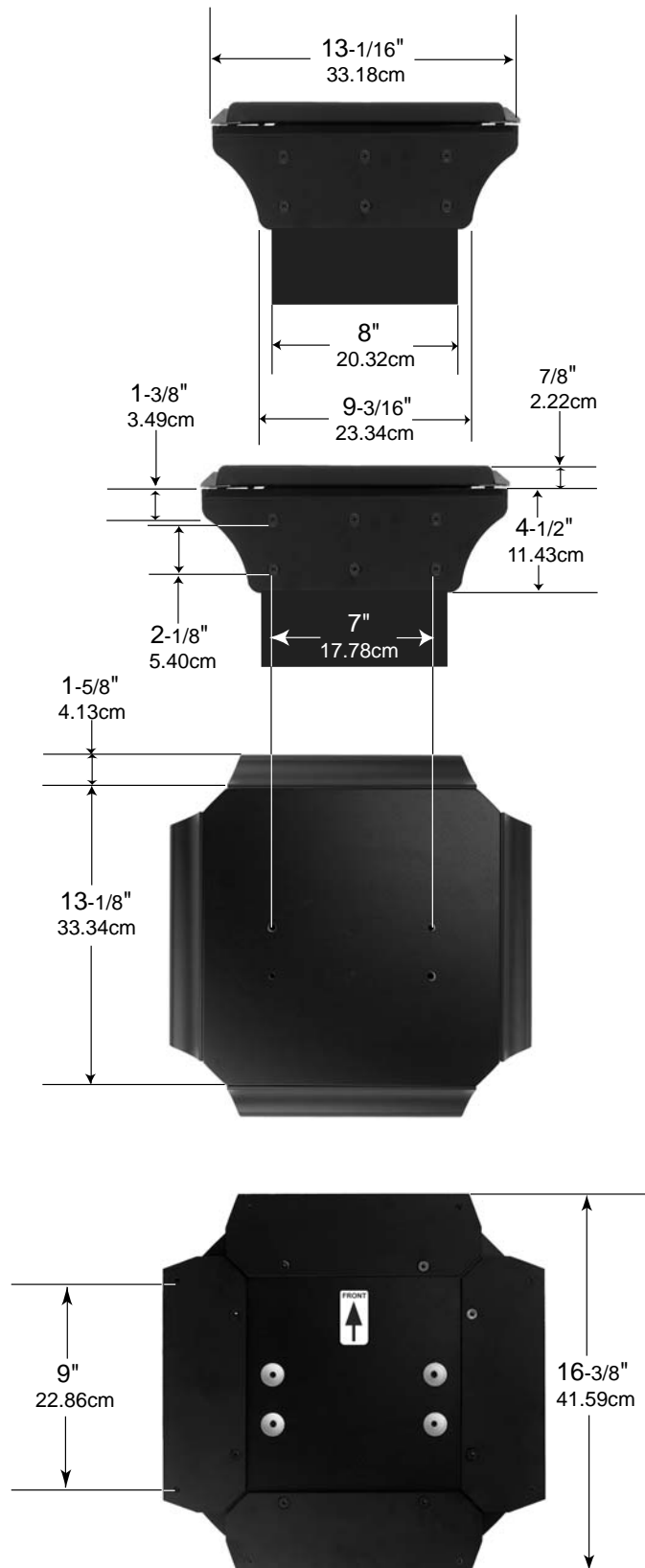

Introduction to Installation

The XRT28 Loudspeaker System weight is 139.5 pounds (63.4kg) net. It requires two or more persons to safely handle during the assembly and placement. The XRT28 is supplied with a McIntosh Column Base. Follow the instructions below for unpacking the Loudspeaker System and attaching the Column Base.

It is recommended that the Professionals at your McIntosh Dealer, who are skilled in all aspects of installation and operation, install the XRT28 Loudspeaker System and any associated audio equipment.

Unpacking the Loudspeaker System

1. Remove the banding material from the shipping carton. Refer to figure 8.

2. Lift off the top of the shipping carton and set it aside.

3. Lift up on the rear of the Loudspeaker, near the foam packing material at both ends.

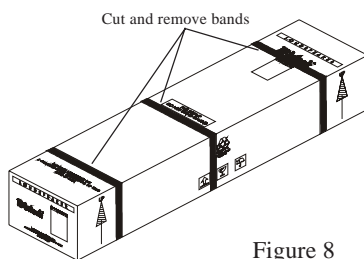

Figure 8

Place the entire assembly (Loudspeaker, Loudspeaker Grille and foam packing material) next to the bottom shipping carton on a flat surface. Refer to figure 9.

4. Release the Loudspeaker Grille from the packing material by opening the slit in the packing material located on the top center. Remove the Loudspeaker Grille from the protective shipping wrap and set it aside.

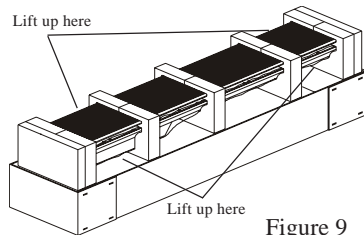

Figure 9

5. In a similar manner, lift out the Loudspeaker and set it aside.
6. Replace the shipping carton top onto the shipping carton bottom. Take the two pieces of the just removed packing material and lay it down flat onto the top of the shipping carton.
7. Carefully remove the protective shipping bag(s) from the Loudspeaker Column so as not to mar the Column Finish or damage the Loudspeaker Drivers.
8. Place the Loudspeaker Column on top of the packing material located on top of the shipping carton making sure to align the Loudspeaker Column Bottom End (the Glass Name Plate end) to the end of the shipping carton. Refer to figure 10.



Figure 10

9. Proceed to step number 10 for installation using the Column Base.

Installation using the Column Base

Unpacking the Column Base

10. Lift and remove the bubble wrap packing material from the base.
11. Locate and remove the bag of hardware and Allen Wrench Tool taped to the bottom of the base.

Assembling the High Frequency Column

12. Using the supplied Allen Wrench, remove two screws from each side of the Column Bottom. Refer to figure 11.

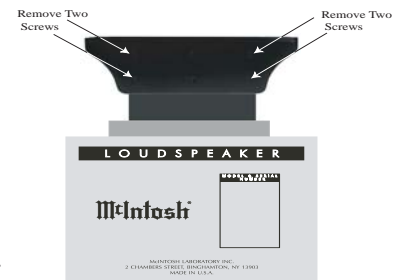
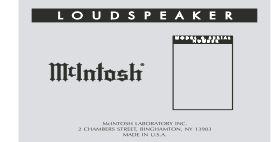

Figure 11

13. Orient the Column Base with the Decal Arrow pointing toward the front of the Loudspeaker Column. Refer to figure 12.



14. Attach the Column Base to the Loudspeaker Column using the four supplied machine bolts and washers. Refer to figure 13.



Figure 12

15. Orient the Loudspeaker Grille with the extended wood trim pointed towards the Column Base and line it up even with the top/sides of the Column. Align the Grille fastening pins to the Column Grommets (there are six pins on each side). Carefully push down to secure the Grille to the Column. Refer to figure 14.

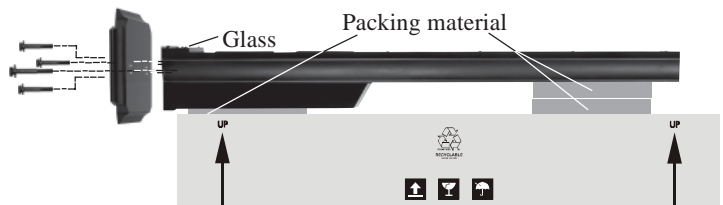

Figure 13



Figure 14

Optional Feet

- Two sets of optional feet (eight Tiptoes and eight Glides) are supplied with the XRT28 Loudspeaker System. Refer to figure 15. To prevent crushing carpet use the Tiptoe Spikes; to protect non-carpeted flooring use the Chrome Glides. Both the Glides and Tiptoes have a threaded shaft and locking nut that screw into the tapped holes in the bottom of the XRT28's base rails. The feet can be independently adjusted to compensate for uneven flooring.
- Stand the Column upright.

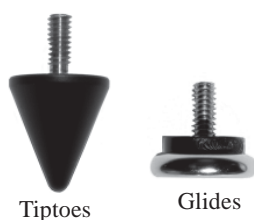

Figure 15

Room Placement using the Column on a Base

Loudspeaker placement in a room can greatly affect performance. The XRT28 Loudspeaker is designed for both Music and Home Theater Systems. The optimal method for selecting speaker locations includes the use of a real time spectrum analyzer operated by an experienced system installer. An uncompromising installation would take into consideration the floor, wall and ceiling coverings, the type and placement of furniture and can even include the architectural design of the room and its construction materials. In those instances where placement in the room is fixed an environmental equalizer may be needed to restore proper musical balance.

Placement near a wall, corner, floor, ceiling or any intersecting surfaces will reinforce or diminish some bass frequencies. The bass frequencies that are altered by placement in a particular location is dependant on the dimensions of the room. If professional measurement equipment is not available, test the various Loudspeaker locations by playing music with continuous bass, setting up the speakers and listening to them from the main listening spot. Move the Loudspeakers to an alternate location and repeat the listening, paying attention to how the bass qualities and response levels change. Do not assume the loudest bass is

best; rather listen for booming (a lack of articulation), as well as a balance over the whole spectrum, to assure the bass will not drown out the other parts of the music. Experiment with various Loudspeaker positions until the location that sound best is found.

The XRT28 Column's Smooth Frequency Response may be altered by large object(s) located in sound waves path or by locating the column too close to a side wall. There should be an unobstructed area in front of the column of at least 30 degrees either side from the center axis for the best performance. Refer to figure 16.

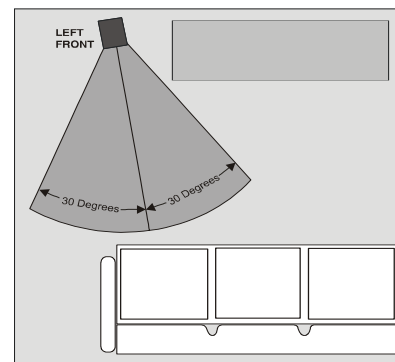

Figure 16

Locating Loudspeakers for use in Home Theater

In a Home Theater application, the placement of Left and Right Front

Loudspeakers can be limited by such considerations as the size and location of the video monitor. The locating suggestions in the "for use in a Music System" section below can still be helpful as a starting place. Refer to figure 17.

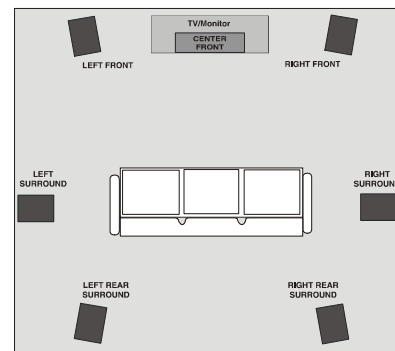

Figure 17

Locating Loudspeakers for use in a Music System

When used in a Music System the distance between the Loudspeakers and the listener to the Loudspeakers should form an equilateral or acute isosceles triangle. If the speakers are too far apart relative to the listener, some imaging can be lost. Refer to figure 18.

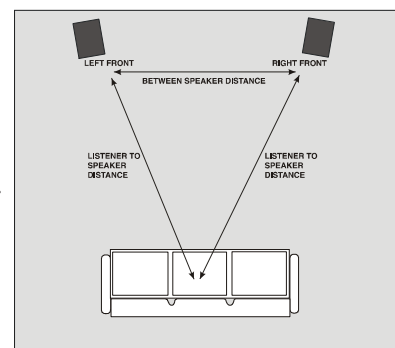

Figure 18

How to Prepare Hookup Cables

The McIntosh XRT28 Loudspeaker System utilizes binding posts for speaker wire connections. Prepare the Loudspeaker Hookup Cables that attach to the Power Amplifier Output Terminals:

Bare wire cable ends:

Carefully remove sufficient insulation from the cable ends, refer to figures 19, 20 & 21. If the cable is stranded, carefully twist the strands together as tightly as possible.

Note: If desired, the twisted ends can be tinned with solder to keep the strands together and/or attach a spade lug.

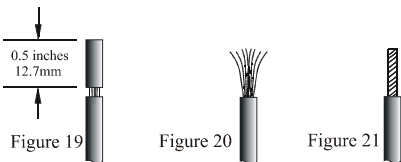

Spade lug or prepared wire connection:

Insert the spade lug connector or prepared section of the cable end into the terminal side access hole, and tighten the terminal cap until the cable is firmly clamped into the terminal so the wires cannot slip out. Refer to figures 22, 23 & 24.

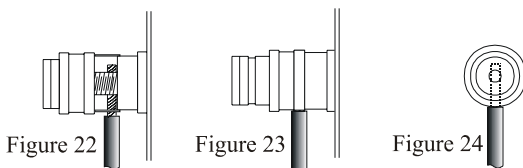

How to Connect using a single Amplifier

1. Connect a Loudspeaker cable from the Negative (-) Binding Post of the Amplifier to the XRT28 Loudspeaker System LOW COMMon (-) Binding Post.
2. Connect a Loudspeaker cable from the Positive (+) Binding Post of the Amplifier to the XRT28 Loudspeaker System LOW 4Ω (+) Binding Post.

Note: For full audible range operation, jumpers must be in place between the MID and HIGH COMMon (-) Binding Posts, the MID and HIGH 4Ω (+) Binding Posts, the MID and LOW COMMon (-) Binding Posts and the MID and LOW 4Ω (+) Binding Posts.

3. Tighten all of the Loudspeaker and Amplifier Binding Posts.

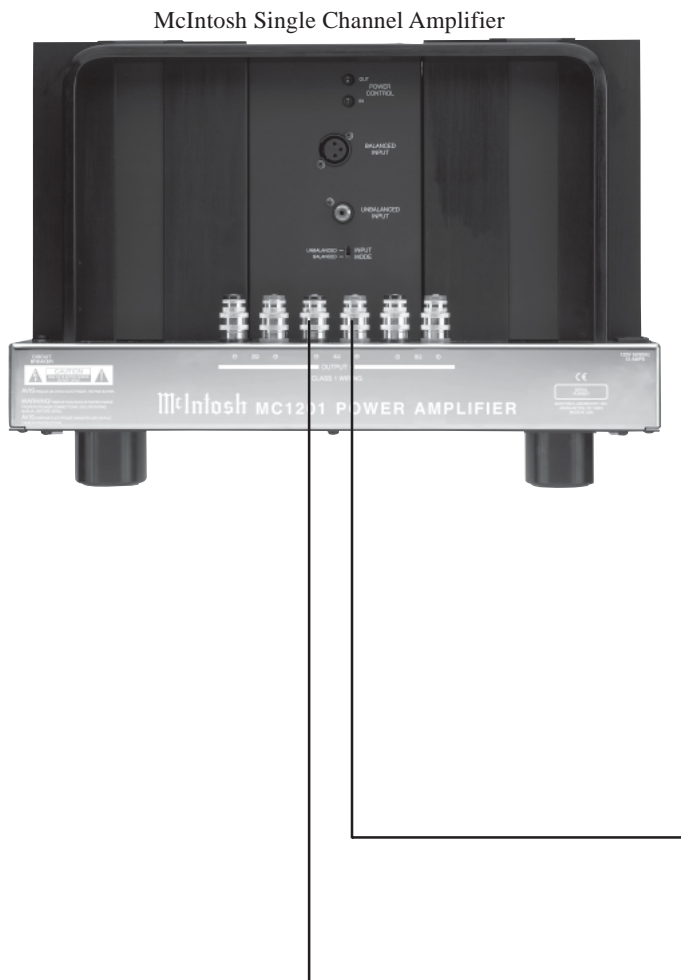



How to Prepare Hookup Cables

The McIntosh XRT28 Loudspeaker System utilizes binding posts for speaker wire connections. Prepare the Loudspeaker Hookup Cables that attach to the Power Amplifier Output Terminals:

Bare wire cable ends:

Carefully remove sufficient insulation from the cable ends, refer to figures 19, 20 & 21. If the cable is stranded, carefully twist the strands together as tightly as possible.

Note: If desired, the twisted ends can be tinned with solder to keep the strands together and/or attach a spade lug.

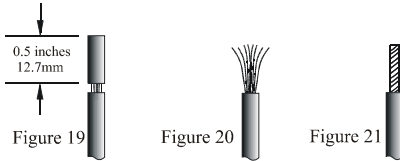

Spade lug or prepared wire connection:

Insert the spade lug connector or prepared section of the cable end into the terminal side access hole, and tighten the terminal cap until the cable is firmly clamped into the terminal so the wires cannot slip out. Refer to figures 22, 23 & 24.

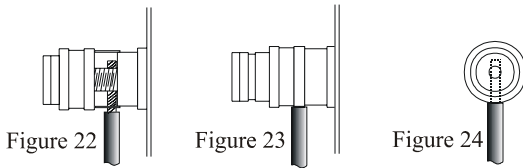

5. Connect a Loudspeaker cable from the Positive (+) Binding Post of the Amplifier Number Two to the XRT28 Loudspeaker System MID 4Ω (+) Binding Post.
6. Tighten all of the Loudspeaker and Amplifier Binding Posts.

McIntosh Single Channel Amplifier Number Two



How to Connect using two Amplifiers

1. Remove jumpers between the MID and LOW COMMon (-) Binding Posts and the MID and LOW 4Ω (+) Binding Posts. The removed jumpers should be retained for possible future use.

Note: For Midrange and High Frequency operation, jumpers must be in place between the MID and HIGH COMMon (-) Binding Posts and the MID and HIGH 4Ω (+) Binding Posts.

2. Connect a Loudspeaker cable from the Negative (-) Binding Post of the Amplifier Number One to the XRT28 Loudspeaker System LOW COMMon (-) Binding Post.
3. Connect a Loudspeaker cable from the Positive (+) Binding Post of the Amplifier Number One to the XRT28 Loudspeaker System LOW 4Ω (+) Binding Post.
4. Connect a Loudspeaker cable from the Negative (-) Binding Post of the Amplifier Number Two to the XRT28 Loudspeaker System MID COMMon (-) Binding Post.

McIntosh Single Channel Amplifier Number One

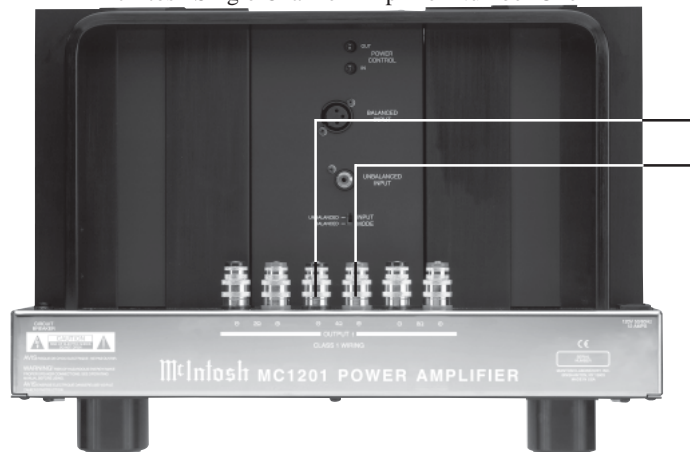

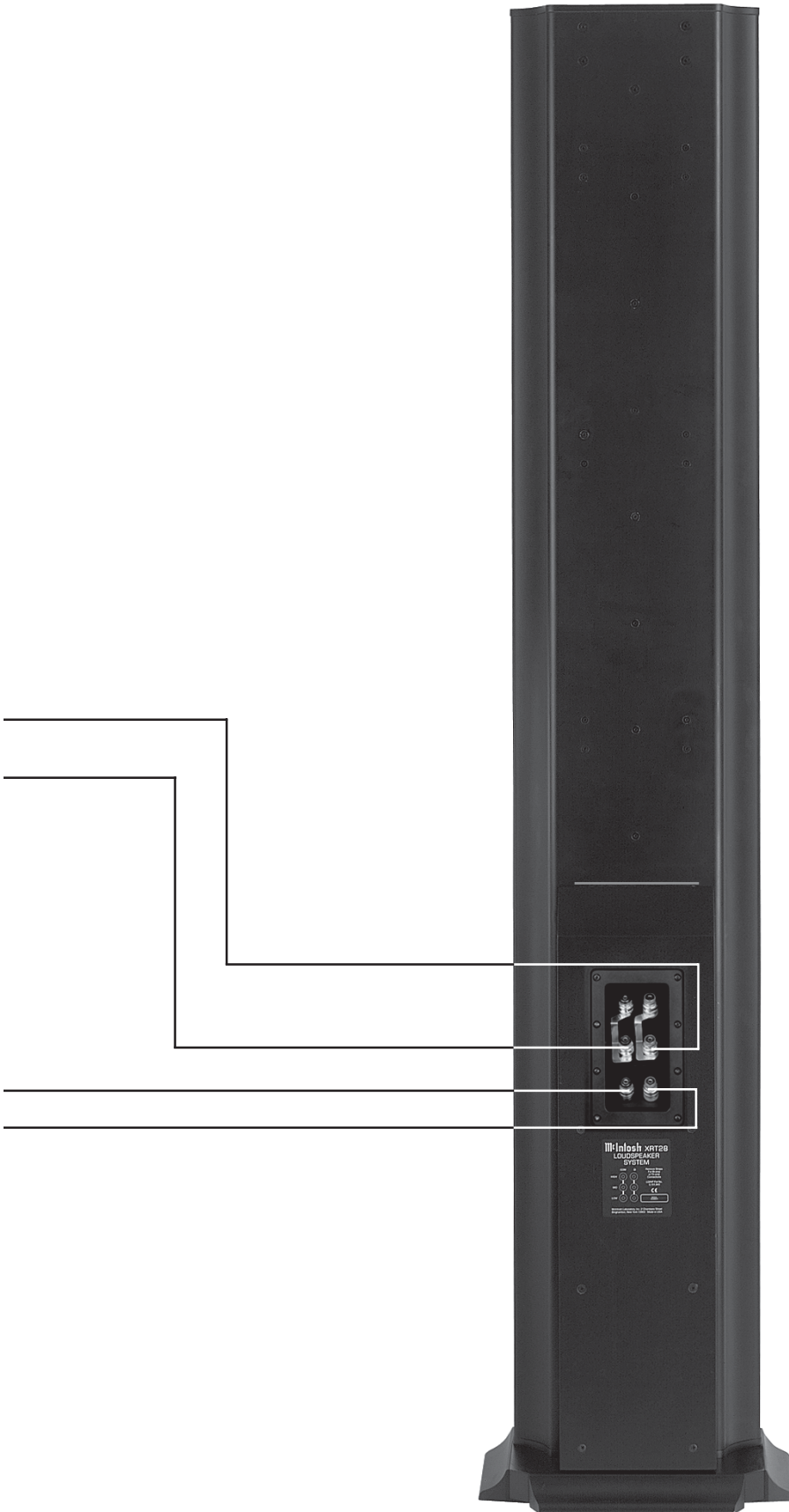

How to Prepare Hookup Cables

The McIntosh XRT28 Loudspeaker System utilizes binding posts for speaker wire connections. Prepare the Loudspeaker Hookup Cables that attach to the Power Amplifier Output Terminals:

Bare wire cable ends:

Carefully remove sufficient insulation from the cable ends, refer to figures 19, 20 & 21. If the cable is stranded, carefully twist the strands together as tightly as possible.

Note: If desired, the twisted ends can be tinned with solder to keep the strands together and/or attach a spade lug.

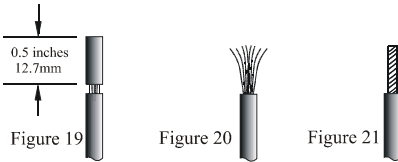

Spade lug or prepared wire connection:

Insert the spade lug connector or prepared section of the cable end into the terminal side access hole, and tighten the terminal cap until the cable is firmly clamped into the terminal so the wires cannot slip out. Refer to figures 22, 23 & 24.

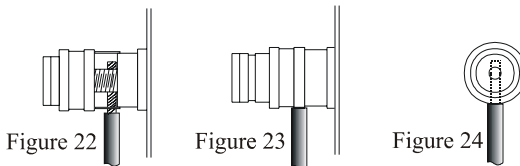

How to Connect using three Amplifiers

1. Remove all the jumpers between the Binding Posts and retain them for possible future use.
2. Connect a Loudspeaker cable from the Negative (-) Binding Post of the Amplifier Number One to the XRT28 Loudspeaker System LOW COMMon (-) Binding Post.
3. Connect a Loudspeaker cable from the Positive (+) Binding Post of the Amplifier Number One to the XRT28 Loudspeaker System LOW 4Ω (+) Binding Post.
4. Connect a Loudspeaker cable from the Negative (-) Binding Post of the Amplifier Number Two to the XRT28 Loudspeaker System MID COMMon (-) Binding Post.
5. Connect a Loudspeaker cable from the Positive (+) Binding Post of the Amplifier Number Two to the XRT28 Loudspeaker System MID 4Ω (+) Binding Post.
6. Connect a Loudspeaker cable from the Negative (-) Binding Post of the Amplifier Number Three to the XRT28 Loudspeaker System HIGH COMMon (-) Binding Post.

7. Connect a Loudspeaker cable from the Positive (+) Binding Post of the Amplifier Number Three to the XRT28 Loudspeaker System HIGH 4Ω (+) Binding Post.
8. Tighten all of the Loudspeaker and Amplifier Binding Posts.

McIntosh Single Channel Amplifier Number Three

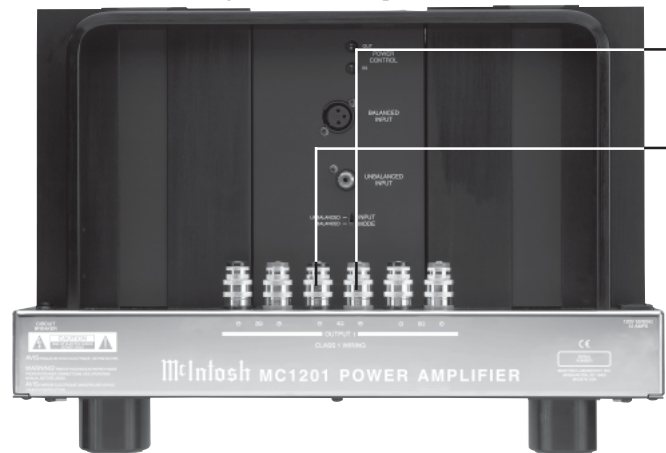

McIntosh Single Channel Amplifier Number Two



McIntosh Single Channel Amplifier Number One

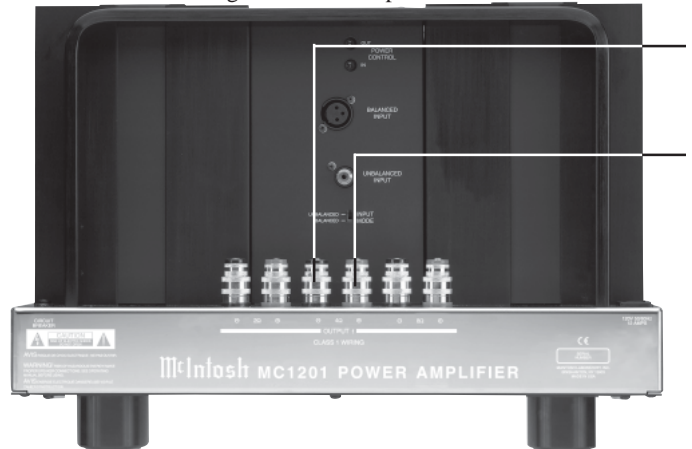

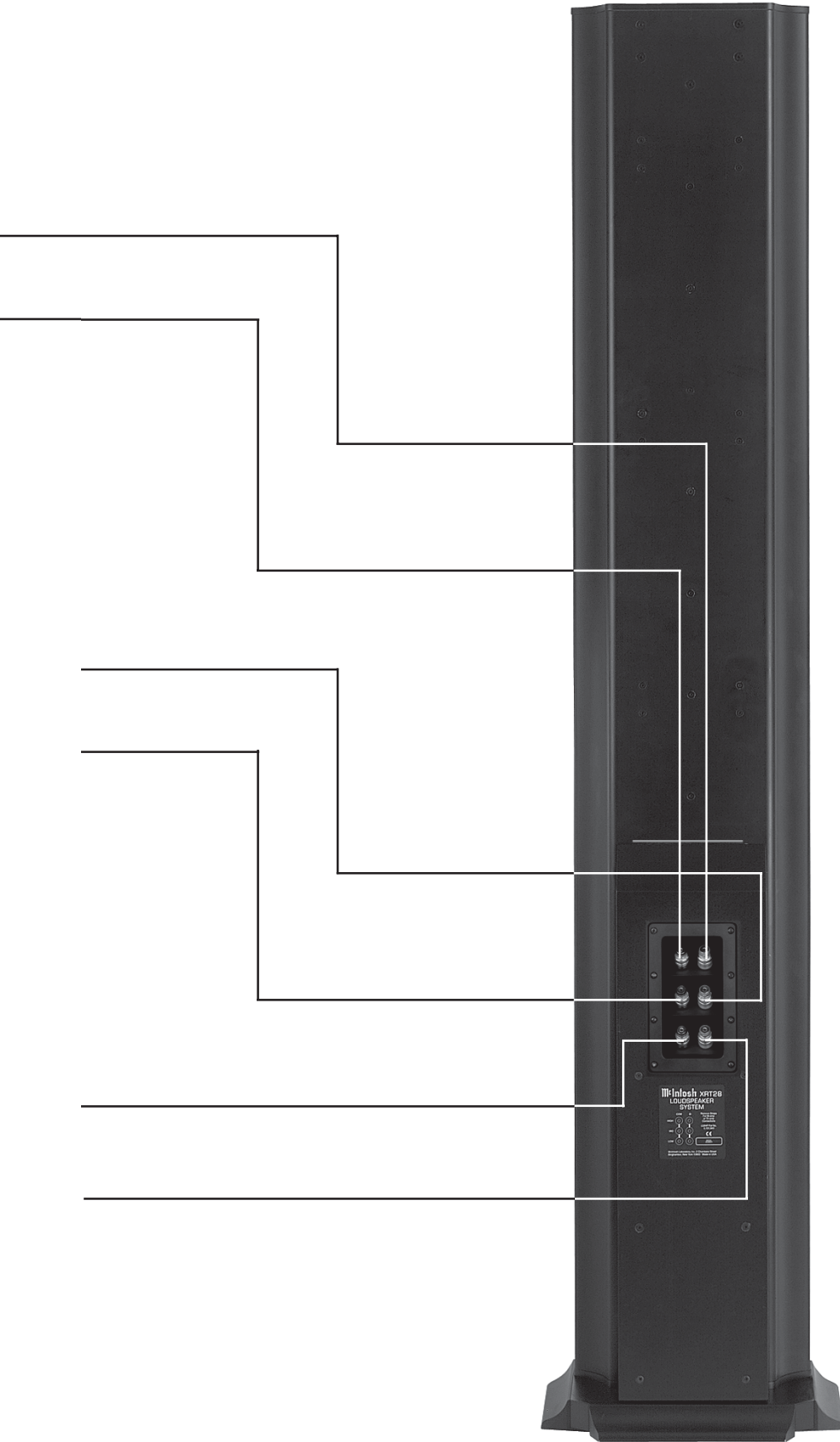

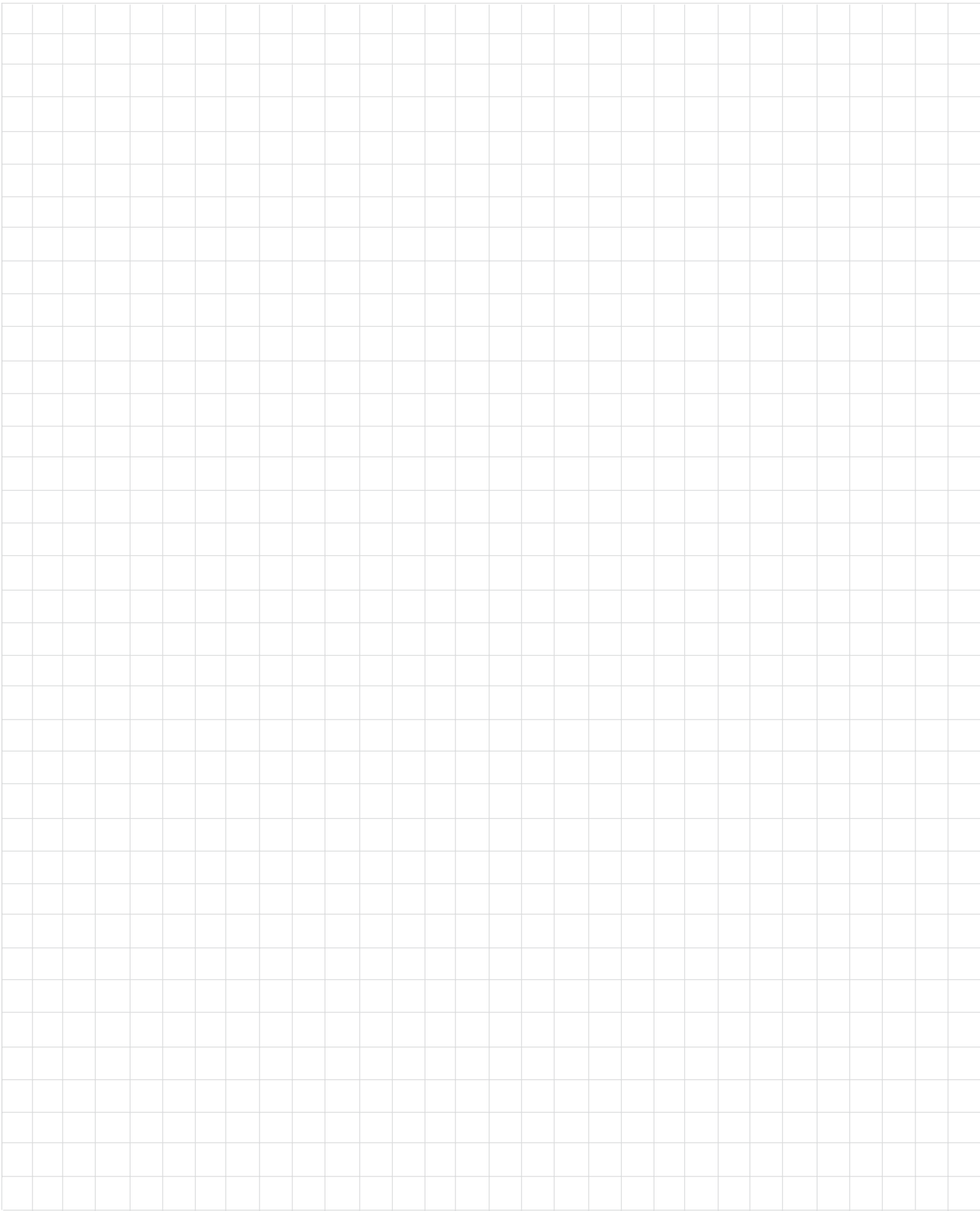

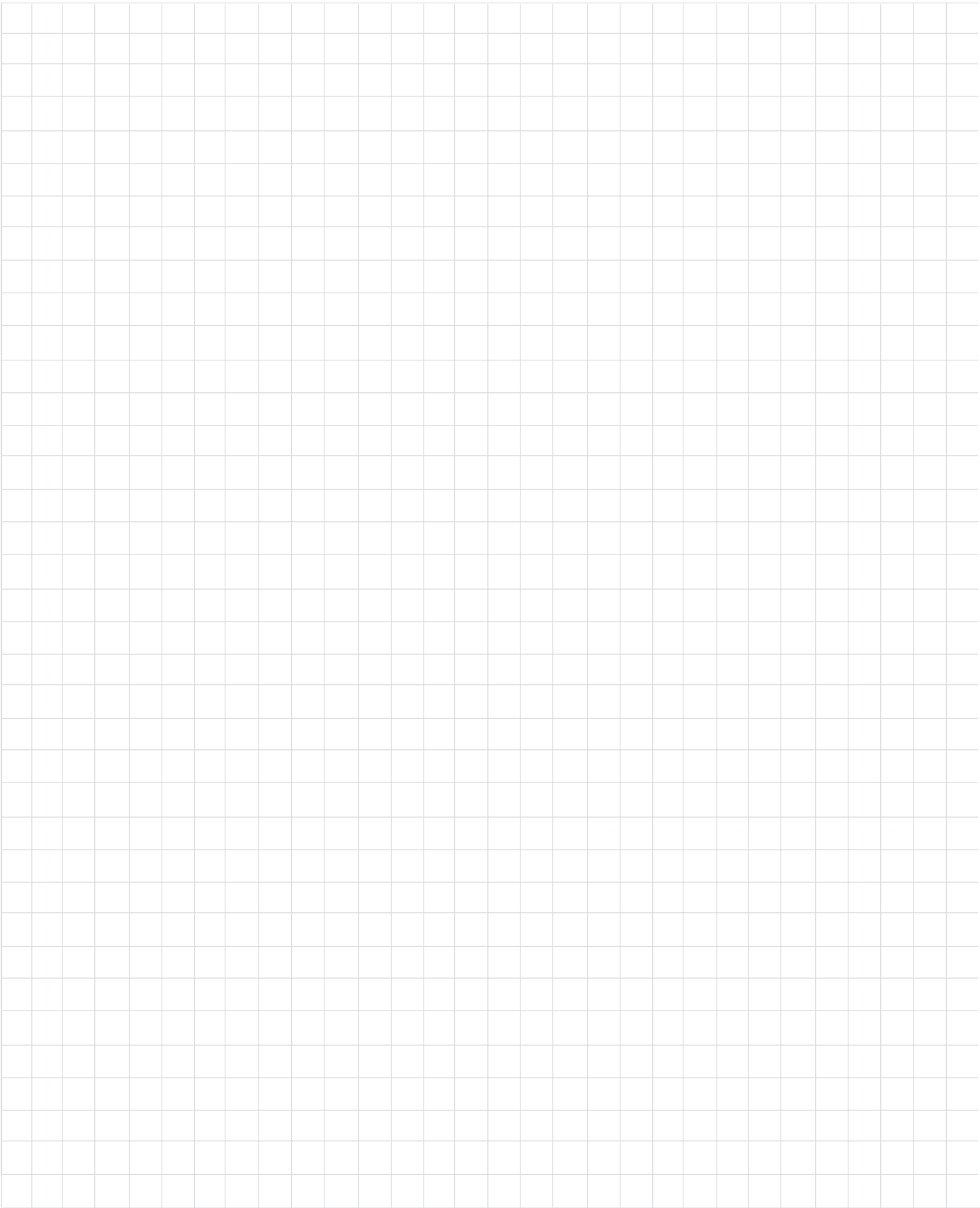

Specifications

System Driver Complement

Two 10 inch LD/HP² Woofers with magnetic shielding
Twenty 4 inch LD/HP² Midranges with magnetic shielding
Sixteen 1 inch Soft Dome Tweeters with magnetic shielding

Impedance

4 ohms Nominal

Frequency Response

16Hz - 20kHz

Sensitivity

88dB (2.8V/1m)

Crossover Frequencies

300Hz
2,000Hz

Power Handling

1200 Watts Maximum

Overall Dimensions

77-1/8 inches (195.90cm) Height, 16-3/8 inches (41.59cm)
Width, 16-3/8 inches (41.59cm) Depth

Finish

Black Ash, Natural Cherry, Red Cherry

Weight

Loudspeaker Column:
124 pounds (56.25kg) net, 146.5 pounds (66.6kg) in
shipping carton

Column Base:

15.5 pounds (7.03kg) net, 18 pounds (8.16kg) in shipping
carton

²LD/HP Pat. No. 5,151,943

Packing Instructions

In the event it is necessary to repack the equipment for shipment, the equipment must be packed exactly as received. Failure to do so will result in shipping damage.

Use the original shipping carton and interior parts only if they are in good serviceable condition. If a shipping carton or any of the interior part(s) are needed, please call or write Customer Service Department of McIntosh Laboratory.

Note: The Loudspeaker System Base is wrapped in bubble pack and placed in a small carton.

Quantity	Part Number	Description
1	034242	Top shipping carton
1	034243	Bottom shipping carton
2	034244	Foam end cap
3	034245	Foam center cap

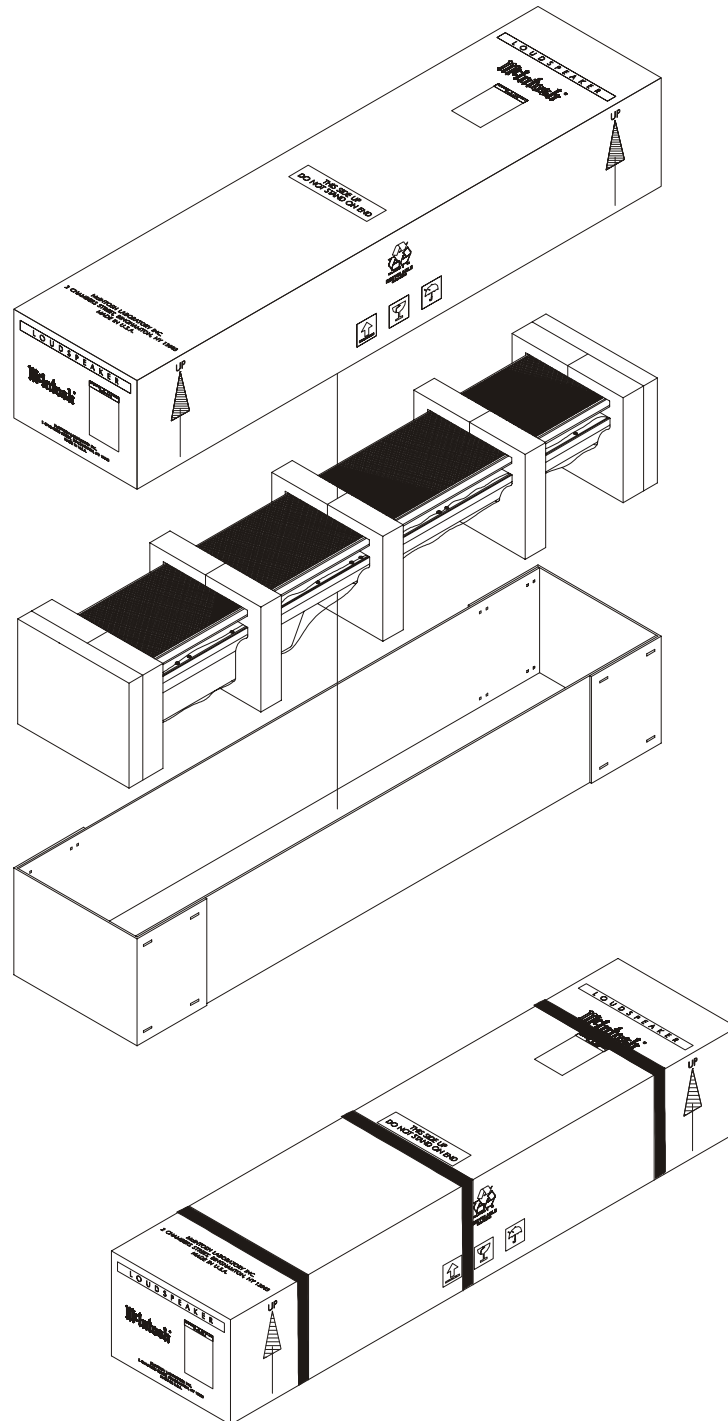



McIntosh Laboratory, Inc.
2 Chambers Street
Binghamton, NY 13903

The continuous improvement of its products is the policy of McIntosh Laboratory Incorporated who reserve the right to improve design without notice.

Printed in the U.S.A.

McIntosh Part No. 04086401